

Left Locked

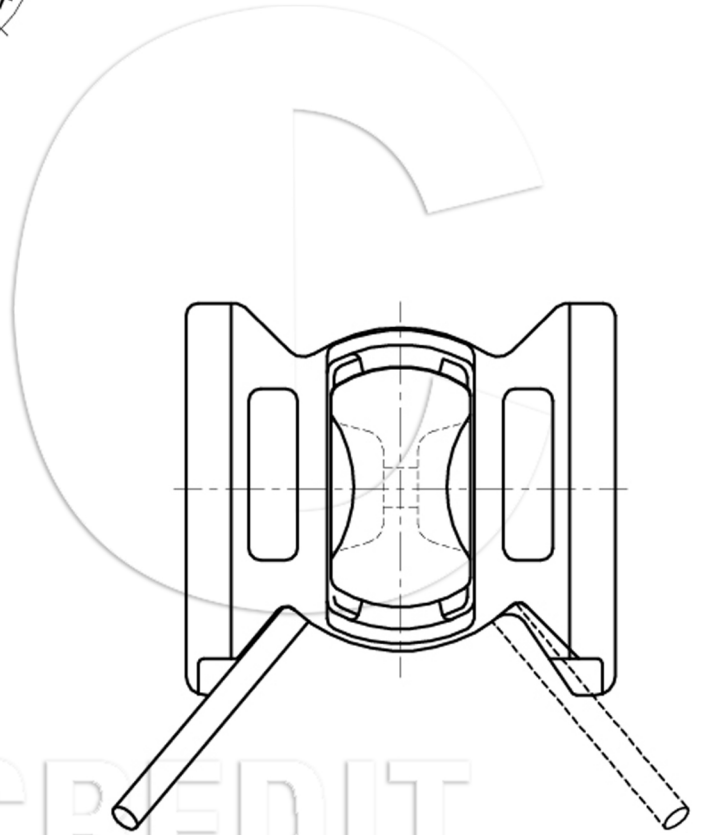

Right Locked

Material: Heat treatable steel
Finish: Hot dip galvanised
Weight: 5.8kg

M.B.L:Tension: 500KN
M.B.L:Shear: 420KN
M.B.L:Compression:2000KN